

# 规格书

## WWT230-03-135

### 6M 工业镜头

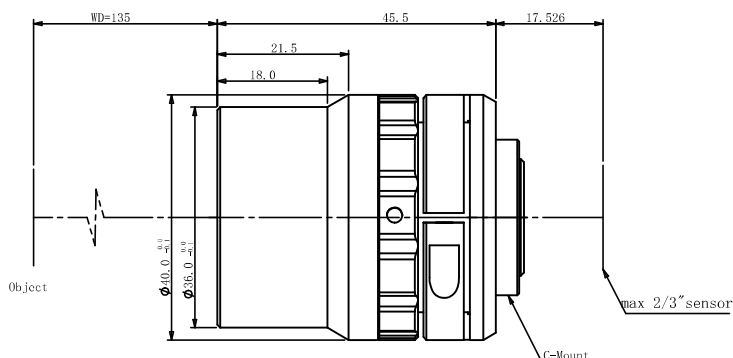

#### 光学参数

放大倍率 $\beta$ (x)	0.3
物方工作距 WD (mm)	135
支持 CCD 尺寸 ( $\Phi$ mm)	11.0(2/3")
像方 F/#	6.0
焦距 (mm)	36.61
数值孔径 NA	0.02493
物方分辨率 ( $\mu$ m)	13.5
物方景深 DoF (mm)	5.3
像方 MTF30 (lp/mm)	121
TV 畸变 (%)	-0.122

#### 视野范围 (mm × mm)

1/1.8" (7.13x5.37)	23.8x17.9
1/1.8" (7.43x4.9)	24.8x16.3
2/3" (8.45x7.1)	28.17x23.67

#### 机械参数

相机接口	C
镜头总长 (mm)	45.5
是否同轴光 / 可调光栏	否 / 否

